

WIRING	
Part 5.	Solder S.
GND	1 GND
GND	2 GND
GND	3 GND
SP	4 SP
12V	5 12V
5V	6 5V
Servicesw	7
Down 2	8
5V	9 5V
Up 1	10 Up 1
CoinCoun	11 Down 1
Coin A	12 Start 2
Reset	13 " " 1
POVT	14 Right 1
POVT	15 Left 1
RED	16 Vid Blue
GREEN	17 Vid Green
BLUE	18 Vid Sync
SYNC	19
GREEN	20
RED	21
POVT	22
RESET	23
RESET	24

DIP-SWITCH	
SW1	ON ON OFF OFF
SW2	ON OFF ON OFF
Frogs	3 5 7 256
SW3	ON OFF
	upright, table
SW4	ON ON OFF OFF
SW5	ON OFF ON OFF
Coin SW1	coin play
Coin SW2	coin play
Coin SW3	coin play
Coin SW4	coin play
Coin SW5	coin play

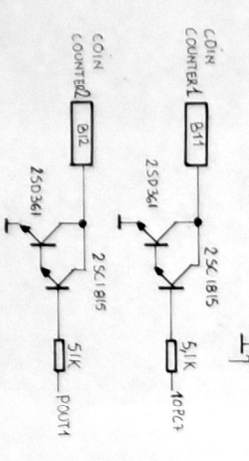

Frogger
SOUND BOARD

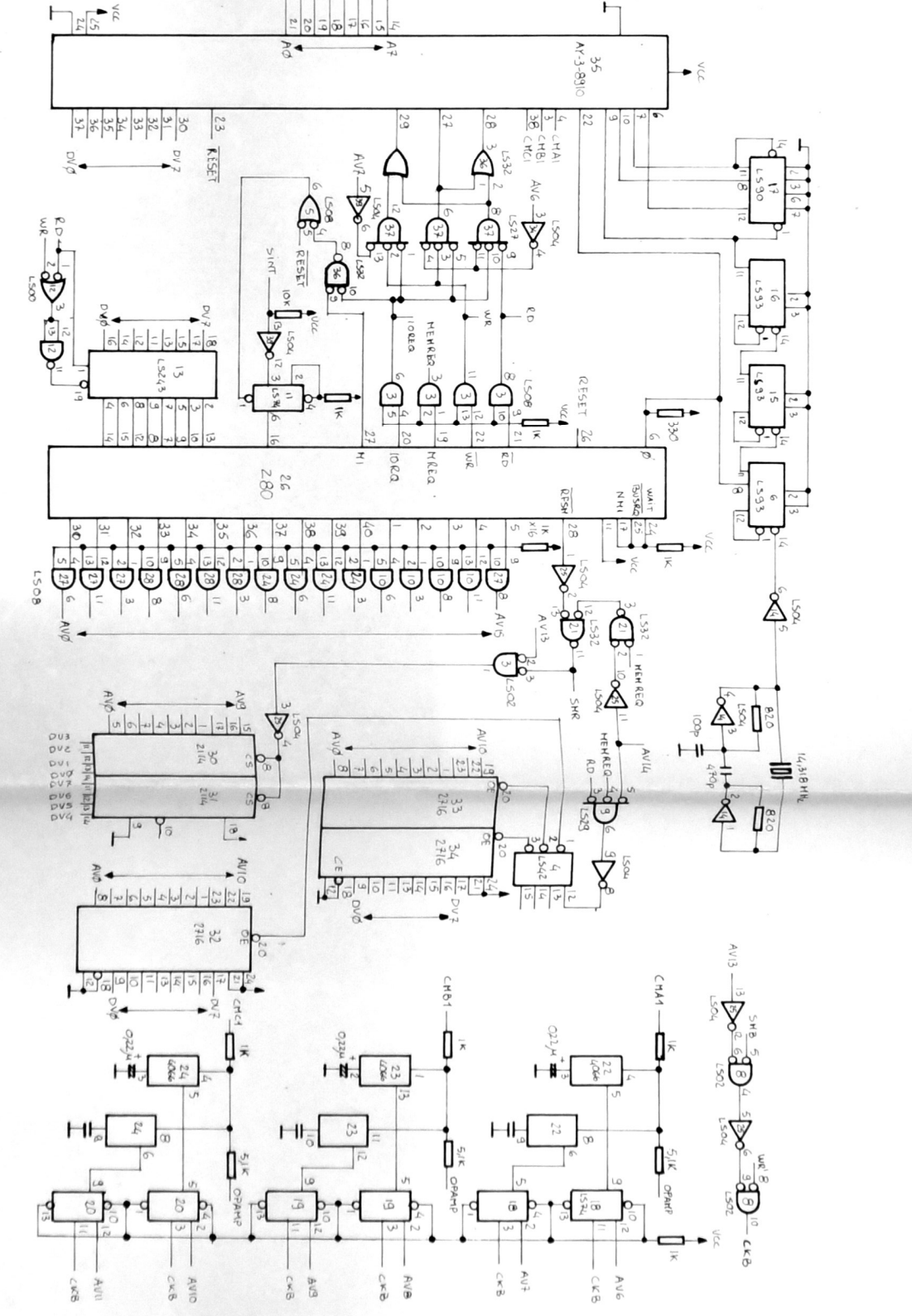
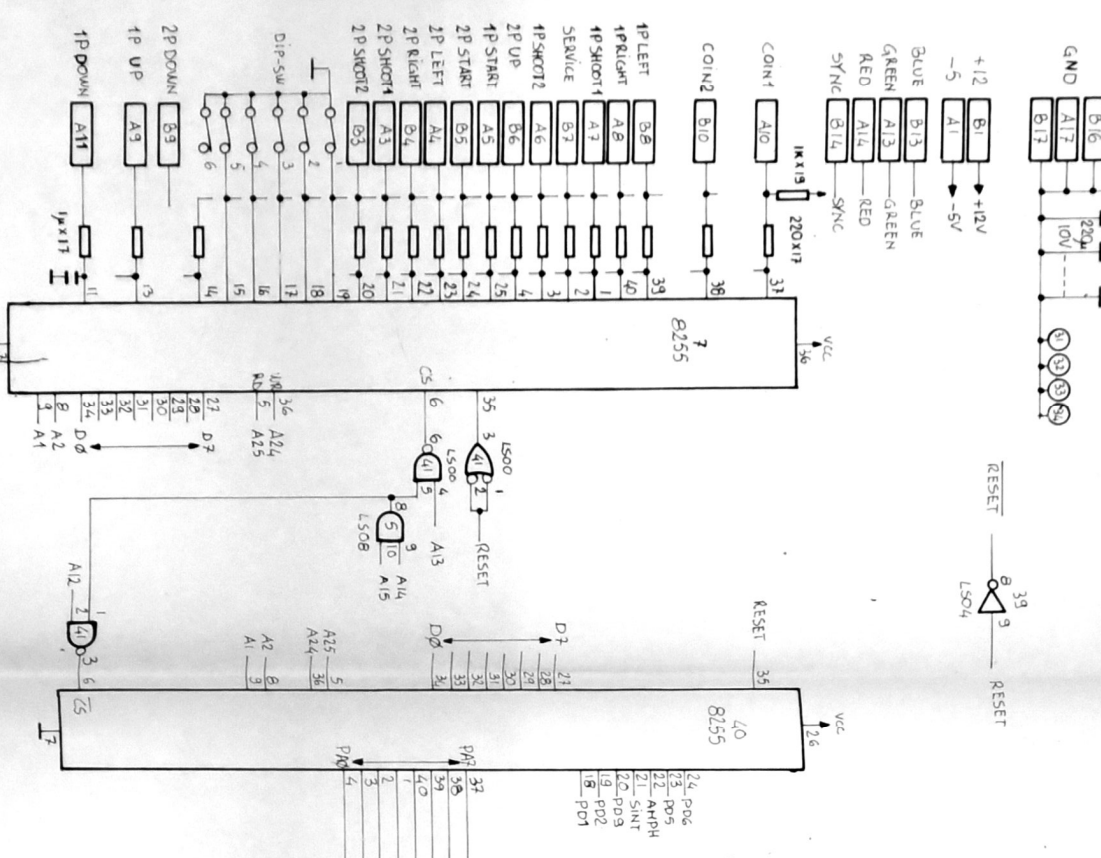
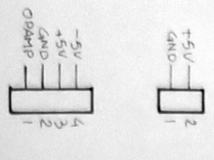
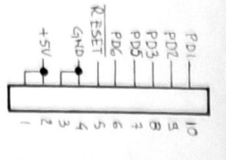
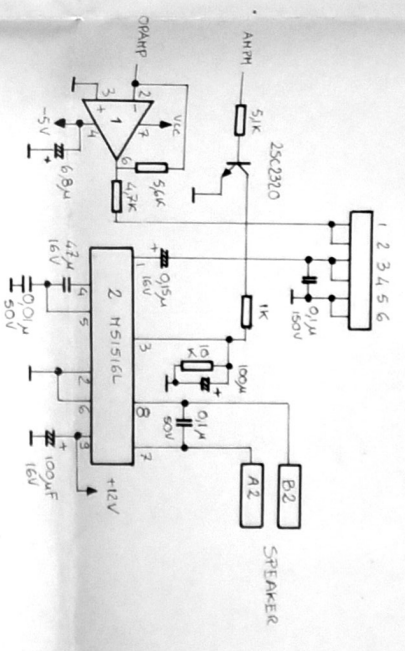
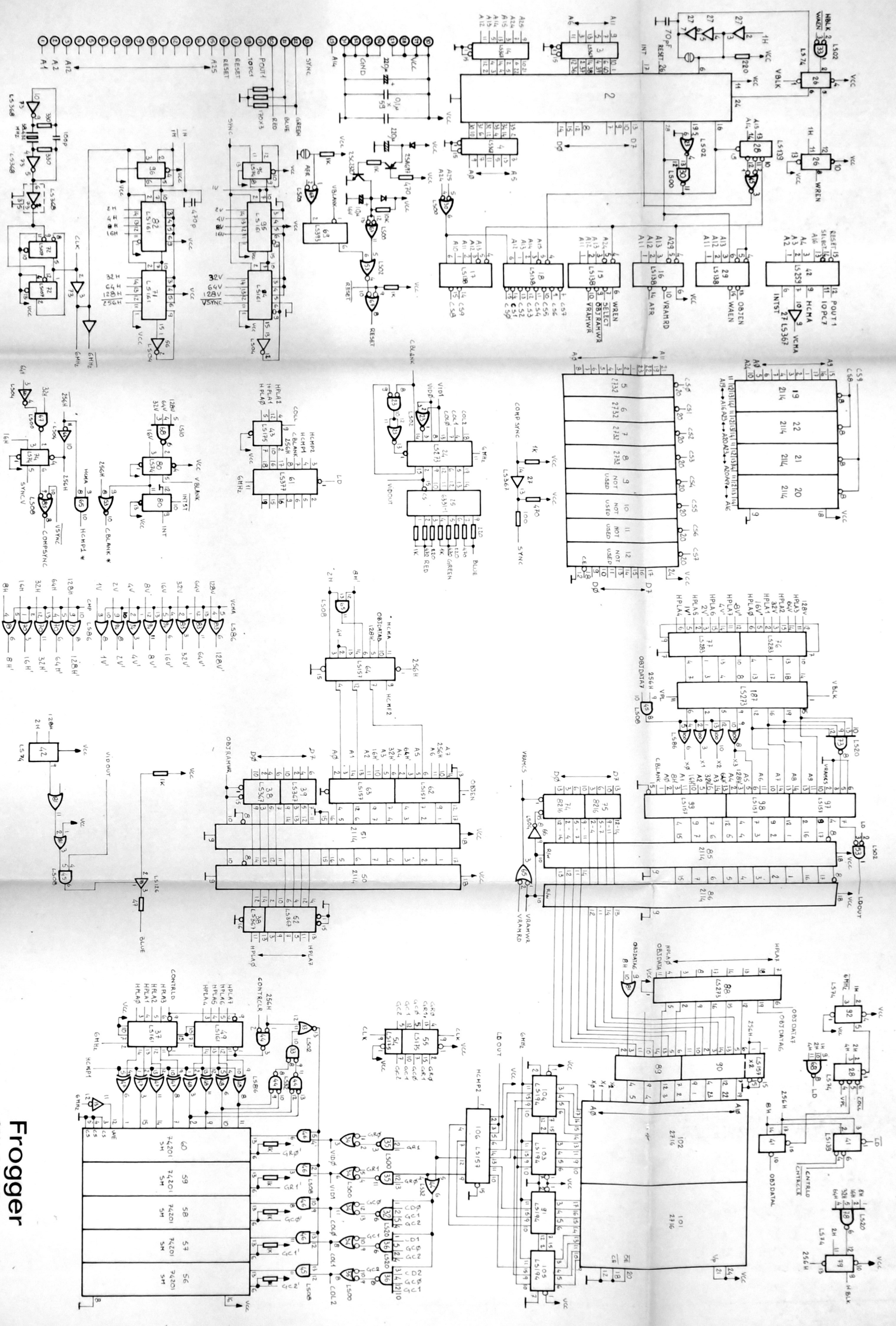

Frogger
CPU BOARD